

A3

| REV | ECN NO | DESCRIPTION | DATE | APPD |
|-----|--------|-----------------|------------|--------|
| X1 | | INITIAL EDITION | 2017.09.25 | Andrew |
| | | | | |

L3200

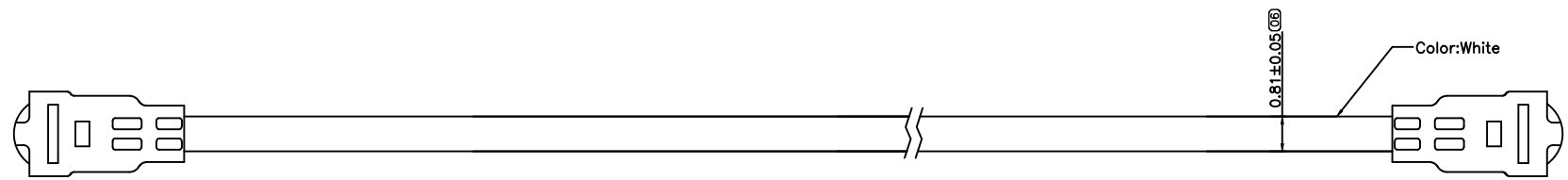
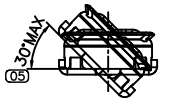
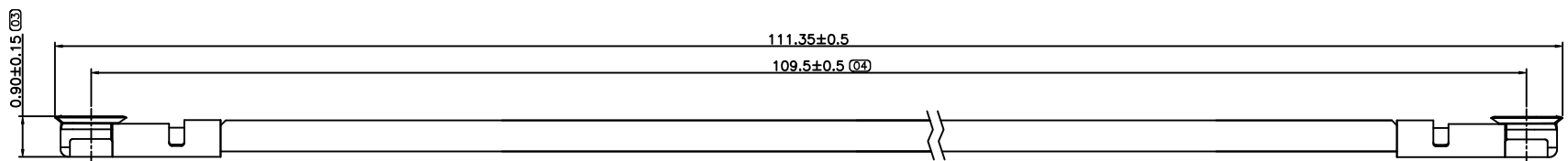
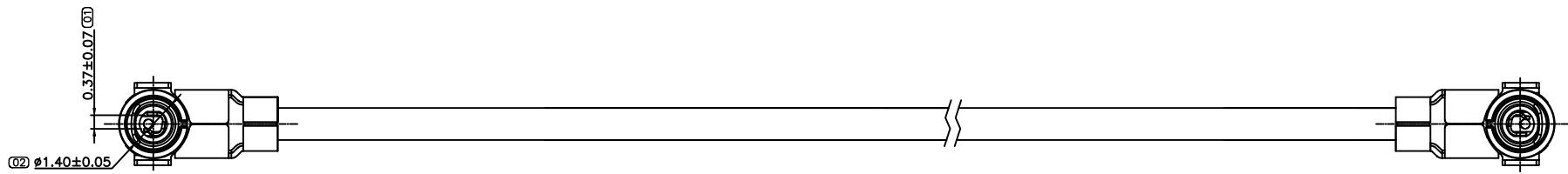

- Note:
- Technology Parameter
 - Voltage Rating: 60VAC(R.M.S)
 - Frequency Rating: 0~6GHz
 - Nominal Characteristic Impedance: 50 ohms
 - Operating Temperature Range: -40°C~+85°C
 - Operating Humidity: 95%R.H.MAX
 - Electric Performance
 - Insulation Resistance: 500M ohms
 - Contact Resistance
 - Inner Contact: 25 mohms Max.
 - Outer Contact: 25 mohms Max.
 - Withstand Voltage: 200V AC 1minute
 - VSWR: 500M~3GHz<1.3
 - Insertion loss:3GHz<0.6dB
 - Mechanism Performance
 - Durability: 30 Cycles
 - The Product is Compliant With FAF Environment Procedure Requirement

| | | | | | |
|---------------------------------|---------|------|---------------------------------------|------------|-----------------|
| EXTEND USE | | | TITLE | | |
| RF 1.2H CONNECTOR PLUG+CABLE | | | 7.023AJ CONNECTOR CUSTOMER DRAWING | | |
| GENERAL TOLERANCE (D) | | UNIT | MATERIAL | APPD | DWG NO |
| DIMENSION | | mm | | Andrew | C-7.023AJ |
| ANGLES | | | QTY | 2017.09.25 | P/N: |
| . ±0.30 | . ±3° | | CHD | | 7.023AJ-068-1B0 |
| .0 ±0.25 | .0 ±2° | | FINISHED | DRN | SHEET |
| .00 ±0.20 | .00 ±1° | | BillZheng | 2017.09.25 | SCALE |
| .000 ±0.10 | | | | | 1/1 |
| | | | | | 1:1 |
| | | | | | (M) |
| | | | | | REV |
| | | | | | X1 |

A3

| REV | ECN NO | DESCRIPTION | DATE | APPD |
|-----|--------|-------------|------|------|
| | | SEE SHEET 1 | | |
| | | | | |
| | | | | |

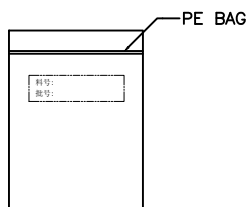

20PCS

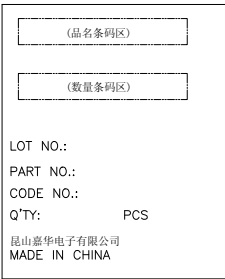

LABLE-INNER BOX

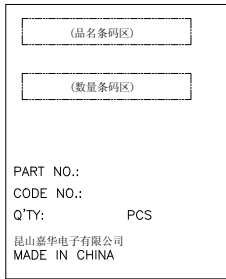

LABLE-CARTON

BOM:

| P/N | Q' TY | | |
|-----------------|--------|-----------|----------|
| | PE BAG | INNER BOX | CARTON |
| 7.023AJ-068-1B0 | 500PCS | 4000PCS | 16000PCS |

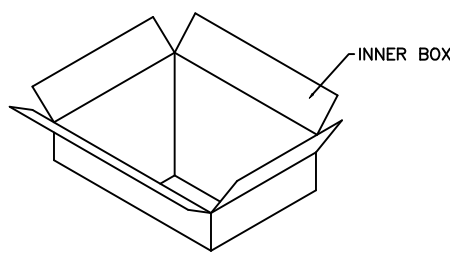

↓

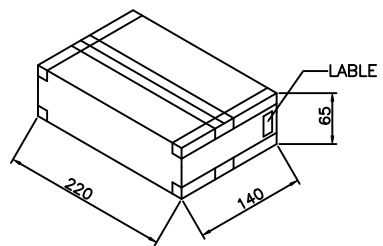

4PCS

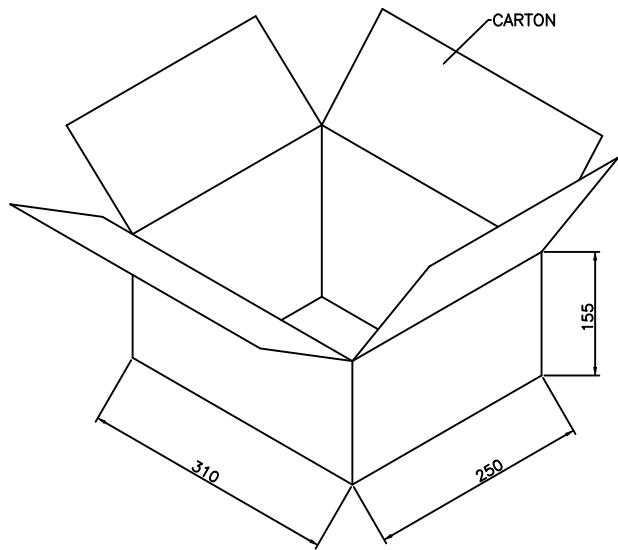

→

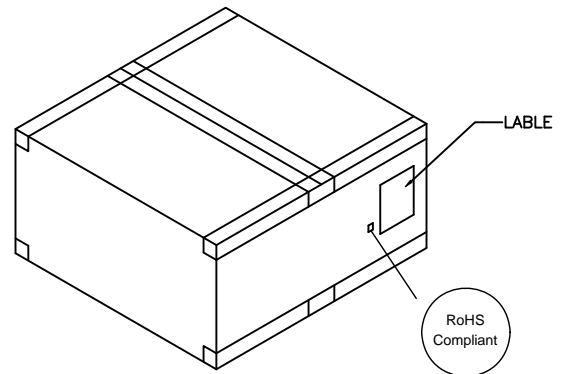

RoHS LABEL

| | | | | | |
|---------------------------------|------------|---------------------------------------|--|-----------|--|
| EXTEND USE | | TITLE | | DWG NO | |
| RF 1.2H CONNECTOR PLUG+CABLE | | 7.023AJ CONNECTOR CUSTOMER DRAWING | | C-7.023AJ | |
| GENERAL TOLERANCE | | MATERIAL | | P/N: | |
| ① | | Andrew 2017.09.25 | | SEE TABLE | |
| DIMENSION | | FINISHED | | SHEET | |
| . ±0.30 | ANGLES ±3° | DRN | | 1/1 | |
| .0 ±0.25 | . ±2° | Billzheng 2017.09.25 | | SCALE | |
| .00 ±0.20 | .00 ±1° | | | 1:1 | |
| .000 ±0.10 | | | | REV | |
| | | | | X1 | |